

DISPLAY DG3 | DG6

30m
IP20 | IP41



green buildings
Gold certified exit sign
luminaire for "sustainable
building" according to
LEED

DISPLAY DG3 | DG6

The Display DG3 | DG6 has a convincing linear design. Only available as a rechargeable battery version, the exit sign luminaire has 7 types of installation to choose from and so it is therefore the ideal exit sign luminaire for any place of use. Whether 1h, 3h or 8h stored energy time, our Display DG3 | DG6 is THE self-contained luminaire for every requirement. At least where design plays a role.



Viewing distance	30 m	
Degree of protection	IP20 (DG6E) IP41(DG3)	
Class	I	
Enclosure material	Sheet steel	
Enclosure colour/surface	RAL 9016 (white)	
Terminal block	3 x 2.5 ² for through wiring	
Light source	LED	
Ambient temperature	0° C to +40° C	
Connected load (AC)	7.6 VA	/6.0 W
	Suspended surface mounted and suspended recessed	
Supply voltage (AC)	230V ± 10 %, 50/60 Hz	
Rechargeable battery	3.6 V/2.5 Ah (NiCd)	

VERSIONS

1 h with auto-check with BUS check	• •
3 h with auto-check with BUS check	• •
8 h with auto-check with BUS check	• •
without monitoring module	
with monitoring module	
with DALI monitoring	
Cinema version	•
Luminous flux in normal mode 10 %	

SPECIAL FEATURE

- Power supply via wire suspension

OPTIONS /ACCESSORIES

- Wire lengths up to 6 m | - Enclosure made of brushed stainless steel | - Ball guard | - Other RAL colours on request

DG3W WALL MOUNTED

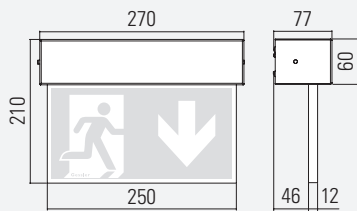

DG3D CEILING MOUNTED

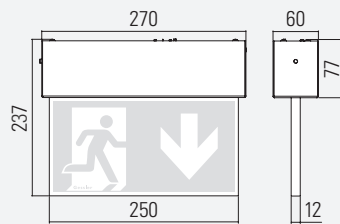

DG3P PENDANT

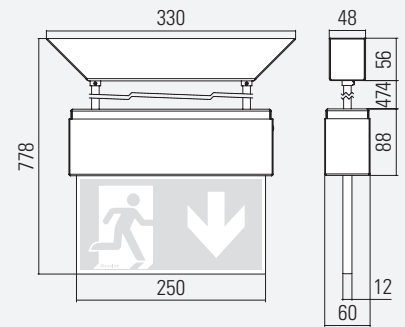

DG3F SUSPENDED, RECESSED BASE

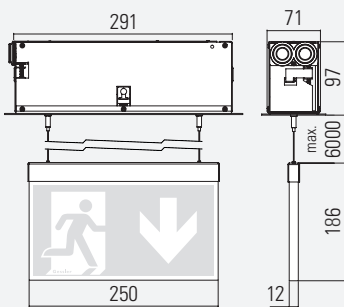

Ceiling cutout: 295 mm x 75 mm
Maximum ceiling thickness: 43 mm

DG3S SUSPENDED

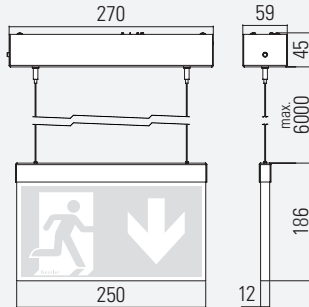

DG6E RECESSED CEILING INSTALLATION

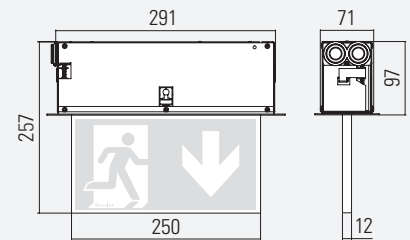

Ceiling cutout: 295 mm x 75 mm
Maximum ceiling thickness: 43 mm

DG3A WALL BRACKET MOUNTING

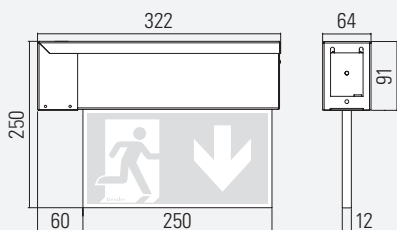

DG3Ö EYE INSTALLATION

